



MK2 range

doc #

## Wall Unit (User Interface)

**MK2Q11**

MK2A25 -- 5 button unit MK2A82 -- 3 button unit MK2A13 -- 2 button unit
---

**Wall mounted user-interface for DEMAN fan-coil, VAV and diffuser controllers.**

**Temperature set-point, fan speed and on/off touch button input and display.**

**Cooling mode, heating mode and on-temperature status display.**

**Low voltage 2 core, polarity insensitive wiring to the above ceiling or under floor controller.**

**Built in room temperature sensor.**

**Elegant enclosure compatible with standard 2x4 draw-boxes.**

**5 button, 3 button and 2 button units as well as "password" protected units.**

**Diagnostic display modes for commissioning and maintenance.**

## Index

---

References	02
Design	03
Dimensions	03
Technical Data	04
Configuration	04
5 button unit	
3 button unit	
2 button unit	
Typical wiring example	05
Diagnostic display modes 5 button unit	06
Diagnostic display modes 2 button unit	07

## Related documents

---

MK2Q20	Setting temperature offset
MK2Q30	Additional diagnostic functions
MK2Q60	5 button input protected unit
M1xQ10	Modular HVAC controller
MM1xQ11	MM1 Fan-coil controller
MMDxQ10	MM1 Diffuser controller
SDVxQ10	SDV HVAC controller

## Design

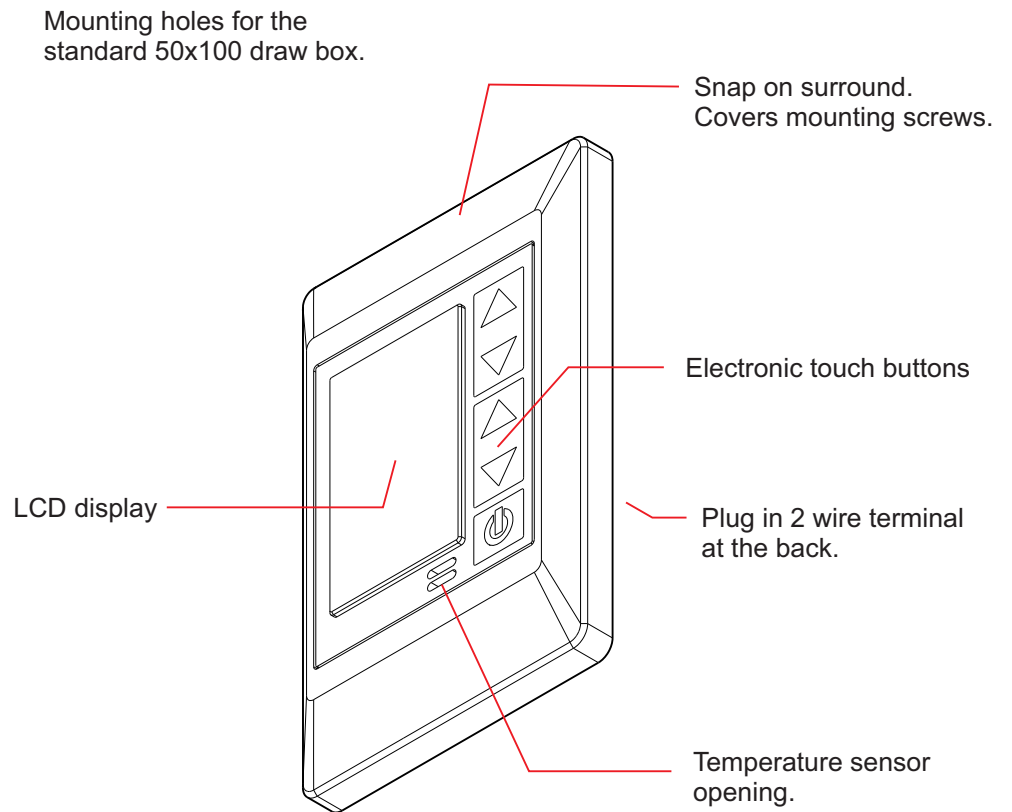

## Dimensions

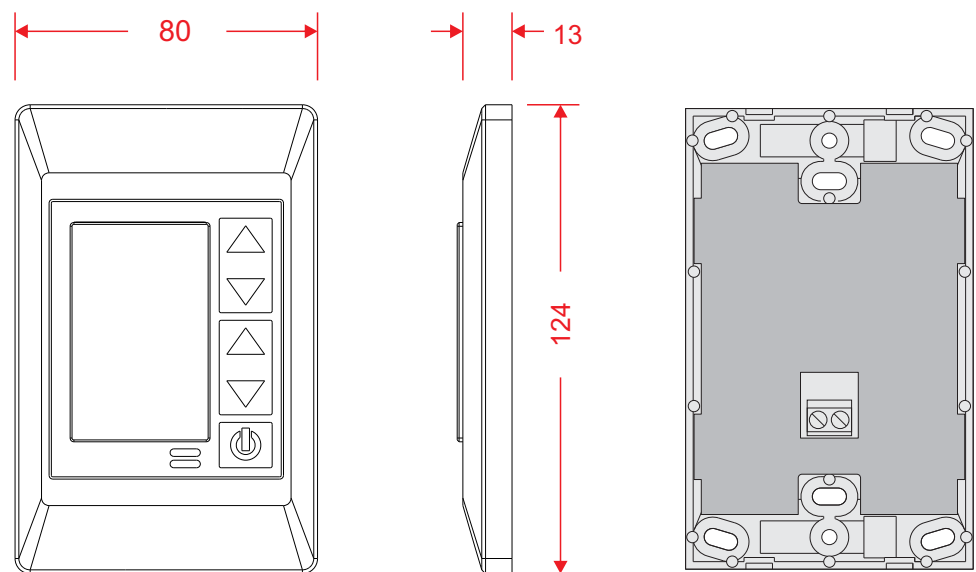

## Technical data

### Communication port

2 wire, polarity insensitive  
connection to controller



### Temperature sensor

Built in temperature sensor. (Temperature sensing is however done at the fan-coil, VAV or diffuser controller if the return air temperature sensor is plugged in.)

### Power

Isolated from mains 12V power from the controller via the signal cable.

### Functions

Temperature setpoint: 9 set points, 18 -- 26 deg.C.  
Fan speed: 6 step  
System on/off

### Compatibility

For use with Deman fan-coil, VAV and diffuser controllers.

## Configuration

### 5 button unit

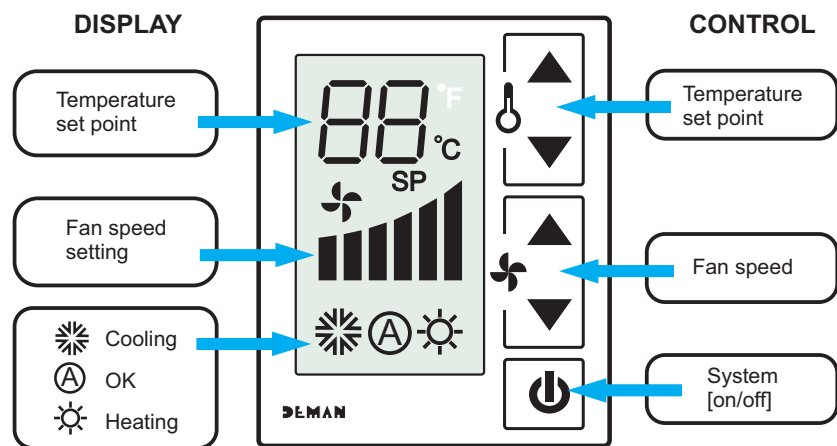

### 3 button unit

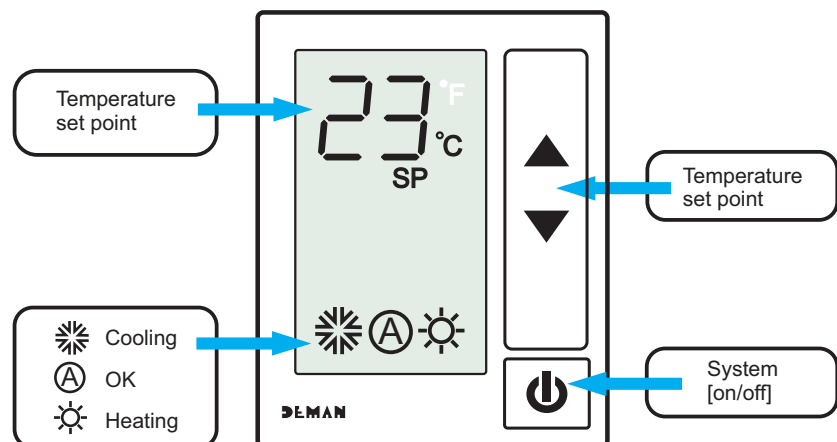

### 2 button unit

3 button unit without the on/off touch button

## Typical wiring example

A typical wiring diagram for a fan-coil controller with LON, discharge air temperature monitoring, occupancy sensing and window monitoring.

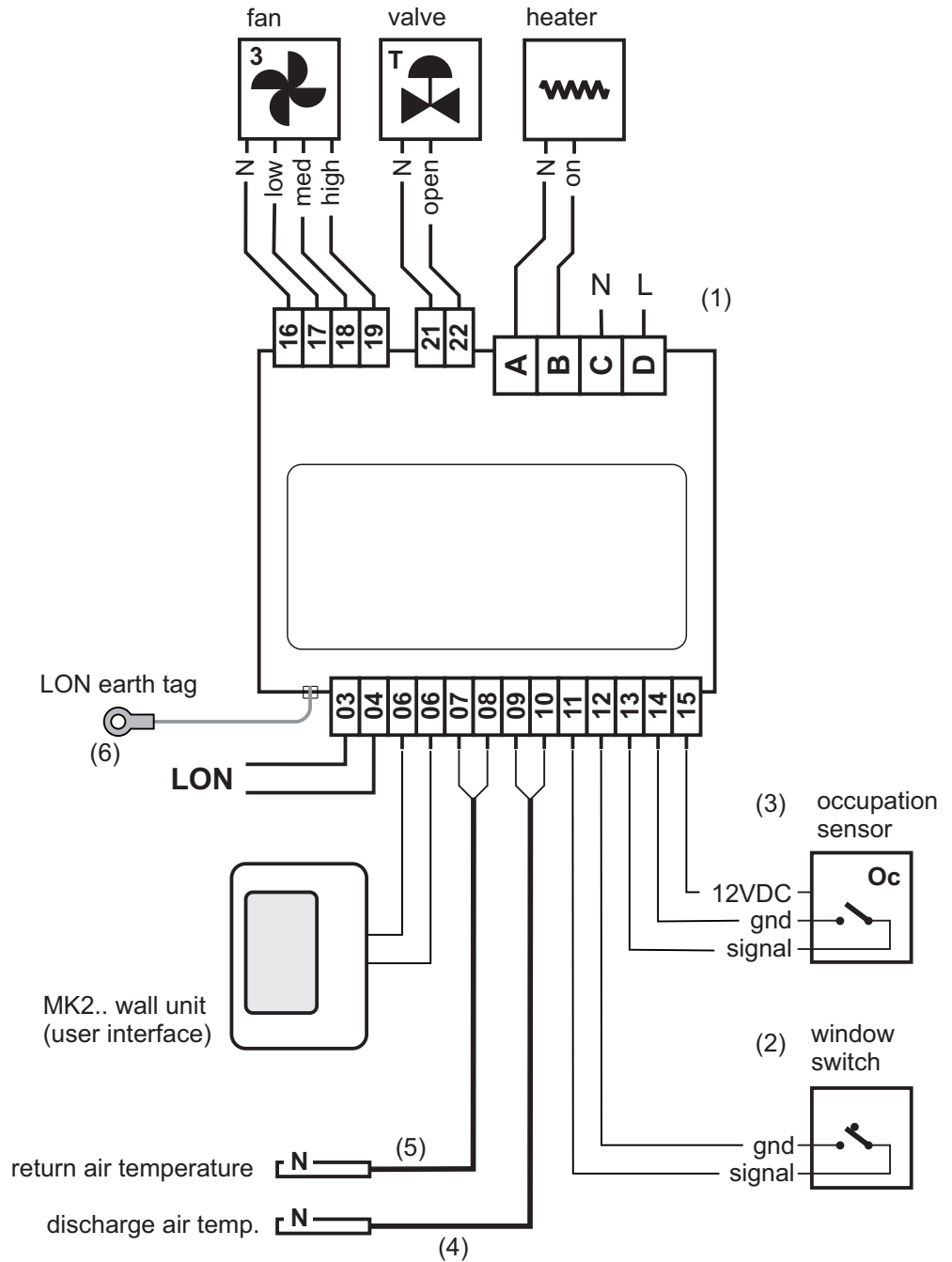

### Notes on this example:

- 1) No Neutral or Live looping on terminals.
- 2) Window open (open contact) -- controller in conserve mode. Bridge if not in use.
- 3) Room unoccupied (open contact) -- controller in unoccupied mode. Bridge if not in use.
- 4) Discharge air temperature is measured for report back on the LON network.
- 5) If the return air temperature sensor is not installed room temperature is measured at the wall unit.
- 6) The earth tag must be wired, directly or indirectly, to 3rd pin Earth.
- 7) 2 wire polarity insensitive wiring to wall unit.

# Diagnostic display modes 5 button unit

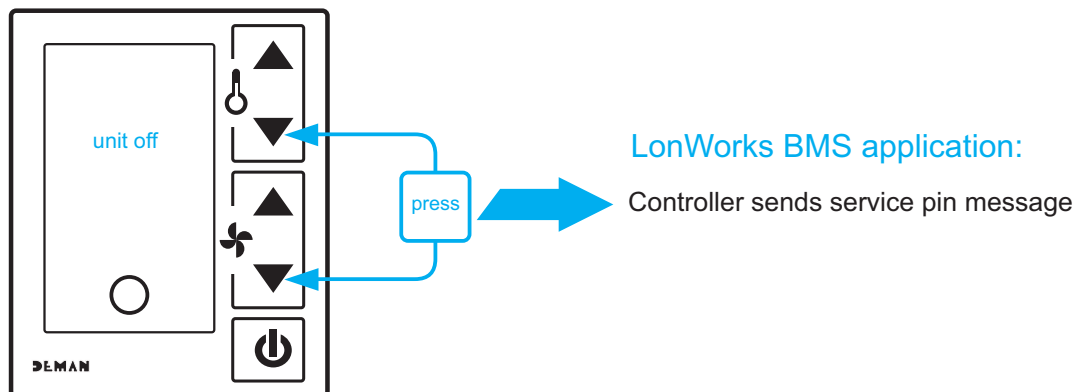
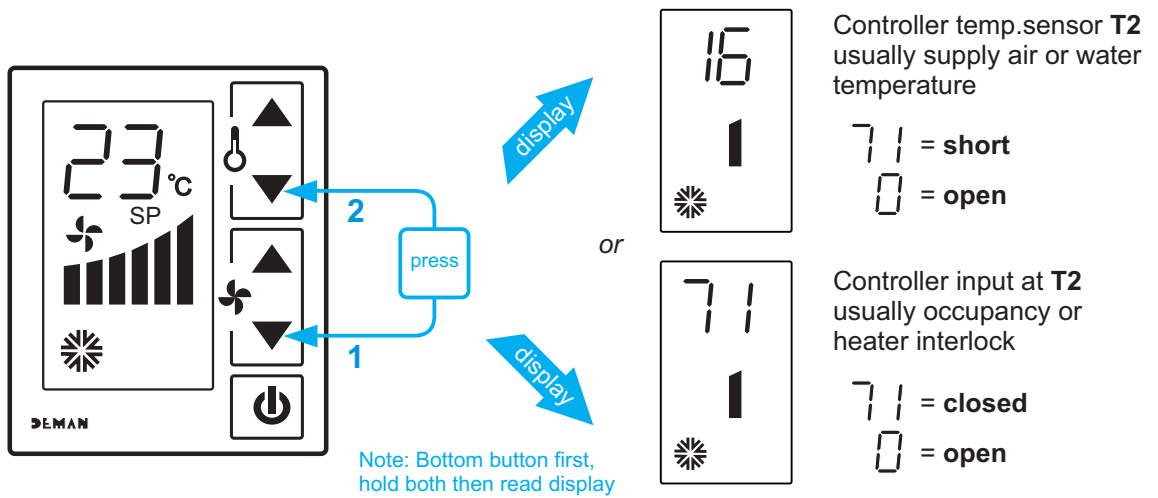
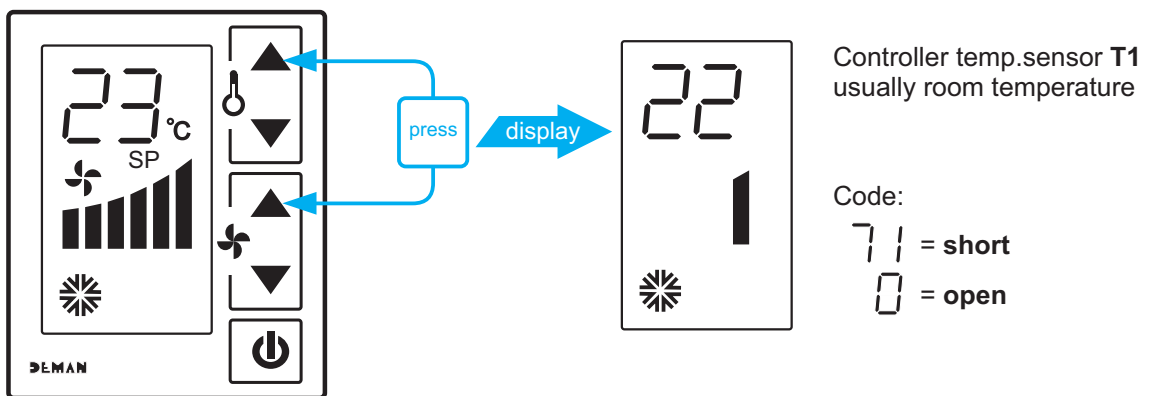
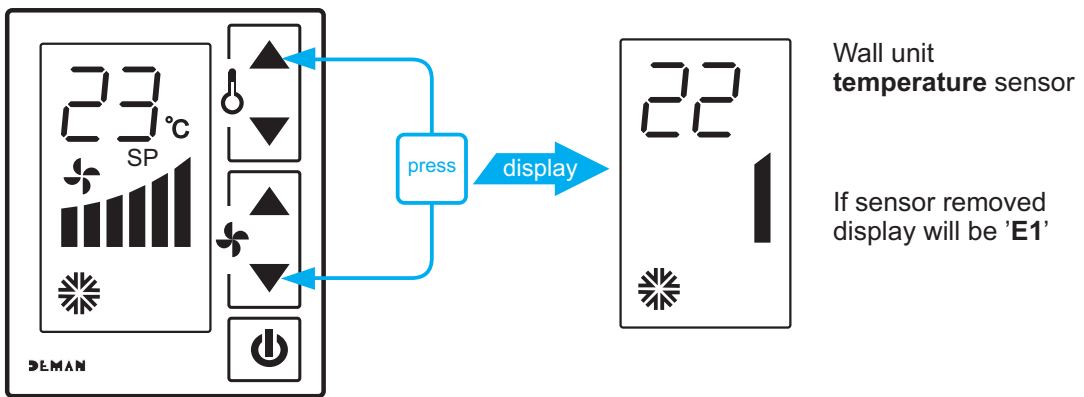

## Diagnostic display modes 2 button unit

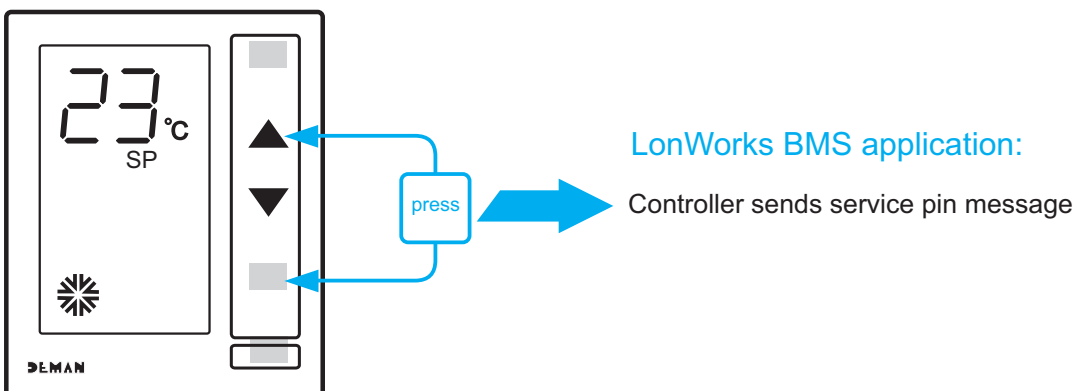
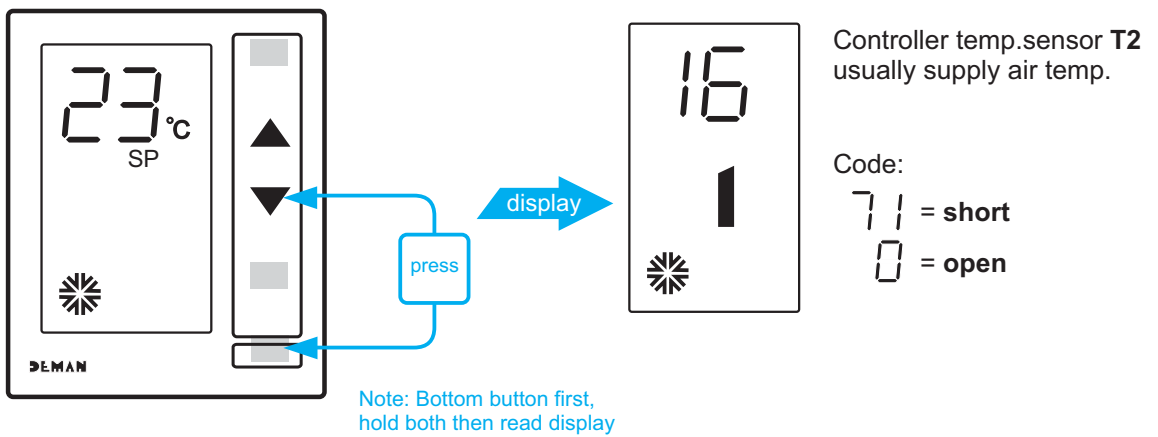
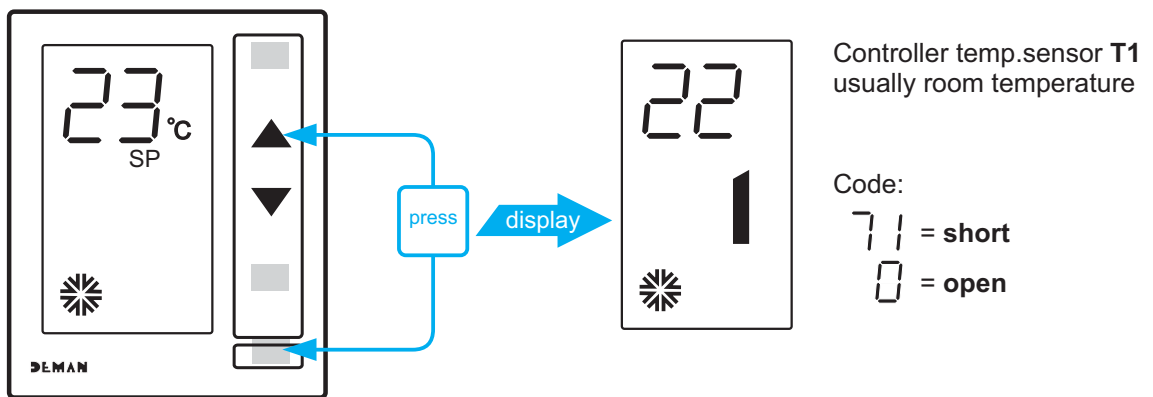
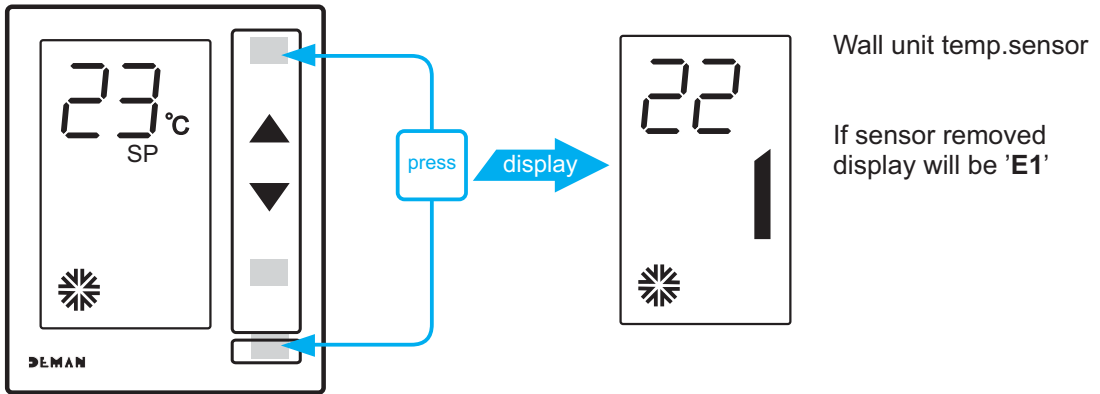

[www.deman.co.za](http://www.deman.co.za)

**Deman Manufacturing (Pty)Ltd**

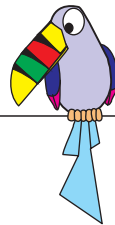

10 Steenbok street  
Koedoespoort  
0186  
Pretoria  
South Africa

PO BOX 26208  
Gezina  
0031  
Pretoria  
South Africa

tel +27 12 403 8000  
fax +27 12 333 3371  
[www.deman.co.za](http://www.deman.co.za)